

# EMERGENCY CARE AND MINOR SURGERY



**JANACH**<sup>®</sup>  
WHERE VISION MEETS PRECISION

SET VIE LACRIMALI MONOUSO / LACRIMAL INSPECTION DISPOSABLE SET CANNULE LACRIMALI MONOUSO / DISPOBLE LACRIMAL CANNULAS	3
PUNCTUM PLUG PER VIE LACRIMALI / LACRIMAL PUNCTUM PLUG SET RICOSTRUZIONE VIE LACRIMALI MONOUSO / NASOLASCRIMAL INTUBATION DISPOSABLE SET	4
SONDE MONOUSO GHIANDOLE MEIBOMIANE / DISPOSABLE MEIBOMIAN GLANDS PROBES GHIANDOLE DI MEIBOMIO / MEIBOMIAN GLANDS INSTRUMENTS	5
BLEFAROSTATI / SPECULUM	6
BLEFAROSTATI MONOUSO / DISPOSABLE SPECULUM	7
VIE LACRIMALI / LACRIMAL TOOLS	8
BISTURI / KNIVES SONDE/DILATATORI / LACRIMAL PROBES AND DILATORS	9
PINZE DEPILATORIE / CILIA FORCEPS	11
STRUMENTI PER CORPI ESTRANEI / FOREIGN BODY TOOLS	12
PINZE DA CALAZIO / CHALAZION FORCEPS	14
CUCCHIAI DA CALAZIO / CHALAZION CURETTES_ PINZE PER PUNTI / STITCH FORCEPS	15
JCP0008 SET PER SUTURA / SUTURING KIT_ JCP0015.1 SET ASPORTAZIONE SUTURA / STITCHES REMOVAL KIT PINZE MONOUSO / DISPOSABLE FORCEPS	16
PINZE ANATOMICHE / DRESSING FORCEPS	17
PINZE SERRAFILI E PER PUNTI / TYNG AND STITCH FORCEPS PINZE MONOUSO / DISPOSABLE FORCEPS	18
FORBICI PER PUNTI E CHIRURGIA / STITCH AND SURGERY SCISSORS	19
PORT'AGHI / NEEDLE HOLDER	21
ELEVATORI PALPEBRALI / LID RETRACTORS	22
SCATOLE / STERILIZATION TRAYS	23
CAUTERIO / CAUTERY CAUTERIO MONOUSO / DISPOSABLE CAUTERY	24
ASCIUGHINI/SPONGES / ACCESSORI_ACCESSORIES	25
SOLUZIONE DETERGENTE E DISINFETTANTE / CLEANING AND DISINFECTANT SOLUTION	26

tabella di conversione		conversion chart		mm/gauge			
Ø mm	gauge	Ø mm	gauge	Ø mm	gauge	Ø mm	gauge
0.30	30	0.55	24	1.00/1.10	19	2.00/2.10	14
0.35	28	0.60	23	1.20/1.30	18	2.40	13
0.40	27	0.70	22	1.40/1.50	17	2.80	12
0.45	26	0.80	21	1.60	16	3.00	11
0.50	25	0.90	20	1.80	15	3.00	10
						4.00	8

# JD2622 SET VIE LACRIMALI/LACRIMAL INSPECTION SET

5 PER BOX STERILE

★ BEST SELLER

**set composto da:  
includes:**

. Dilatatore vie lacrimali, sottile  
Lacrimal dilator, fine

. Cannula curva **26G** x 1¼" (0.45 x 32 mm), lunghezza 33 mm  
**26G** x 1¼" (0.45 x 32 mm), curved cannula, 33 mm long

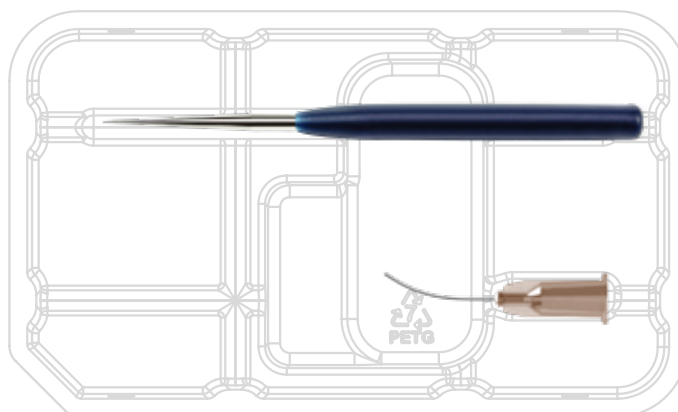

## DILATATORE LACRIMALE MONOUSO/DISPOSABLE LACRIMAL DILATOR



STERILE EO



5 Years  
Shelf Life



JD2622.1/10

Dilatatore vie lacrimali, sottile

Lacrimal dilator, fine

## CANNULE LACRIMALI MONOUSO/DISPOSABLE LACRIMAL CANNULAS



STERILE EO



5 Years  
Shelf Life

JD90387



Cannula vie lacrimali,  
26G x 1¼" (0.45 x 32 mm) curva

Lachrymal cannula,  
26G x 1¼" (0.45 x 32 mm), curved

JD90388



Cannula vie lacrimali,  
25G x 1 1/8" (0.50 x 29 mm) curva

Lachrymal cannula,  
25G x 1 1/8" (0.50 x 29 mm), curved

JD90393



Cannula vie lacrimali,  
26G (0.45 x 30 mm) curva

Lachrymal cannula,  
26G (0.45 x 30 mm) curved



STERILE R



**PUNCTUM PLUG IN SILICONE**  
PLUGS PER VIE LACRIMALI

**SILICONE PUNCTUM PLUGS**  
LACRIMAL PUNCTUM PLUGS



**OCCLUSIONE A LUNGO TERMINE**

Il caratteristico cappuccio a basso profilo combinato con un silicone più morbido e flessibile massimizza il comfort del paziente. Ora disponibile con due opzioni di inserimento. I SOFT PLUG® sono rimovibili con una pinza (vedi istruzioni per l'uso)

- OA6610 Micro - 2pk, 0.4 mm
- OA6611 Mini - 2pk, 0.5 mm
- OA6612 Petite - 2pk, 0.6 mm
- OA6613 Small - 2pk, 0.7 mm
- OA6614 Medium - 2pk, 0.8 mm

**LONG TERM OCCLUSION**

The distinctive low-profile cap combined with a softer, flexible silicone maximizes patient comfort. Now available with two inserter options. SOFT PLUG® Silicone Punctum Plugs are removable with forceps (see instructions for use)

**PUNCTUM PLUG IN SILICONE**  
**CON CONTROLLO DI FLUSSO**  
PLUGS PER VIE LACRIMALI

**SILICONE FLOW CONTROL**  
**PUNCTUM PLUGS**  
LACRIMAL PUNCTUM PLUGS



**OCCLUSIONE A LUNGO TERMINE**  
**CON DRENAGGIO PARZIALE**

Il caratteristico cappuccio a basso profilo combinato con un silicone più morbido e flessibile massimizza il comfort del paziente. L'inseritore riduce al minimo il rischio di rilascio accidentale del plug. Il plug è progettato con un canale centrale che consente un flusso lacrimale parziale. I SOFT PLUG® con controllo di flusso sono rimovibili con una pinza (vedi istruzioni per l'uso)

- OA6612-FC Petite - 2pk, 0.6 mm
- OA6613-FC Small - 2pk, 0.7 mm
- OA6614-FC Medium - 2pk, 0.8 mm

**LONG TERM OCCLUSION**  
**WITH PARTIAL DRAINAGE**

The distinctive low-profile cap combined with a softer, flexible silicone maximizes patient comfort. The inserter minimizes potential for accidental release of the plug. Plug is designed with a center channel allowing for partial tear flow. SOFT PLUG® Flow Control Plugs are removable with forceps (see instructions for use)

# SONDE MONOUSO GHIANDOLE MEIBOMIANE DISPOSABLE MEIBOMIAN GLANDS PROBE

5 PER BOX STERILE



STERILE EO



DRY EYE

Sonde per ghiandole Meibomiane  
ogni misura è fornita in 5 unità per scatola

Probes for Meibomian glands  
each size is provided in 5 units per box

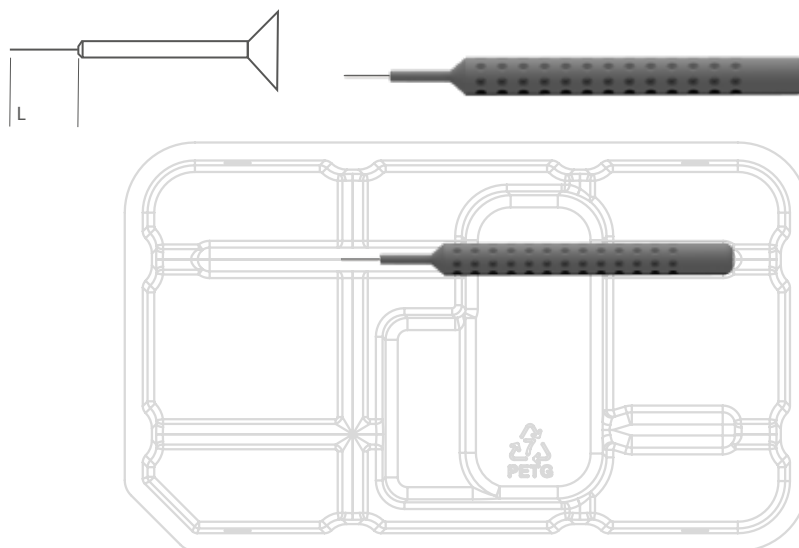

JD2123.2 probe length L=2mm - Ø=0.10mm

JD2123.4 probe length L=4mm - Ø=0.10mm

JD2123.6 probe length L=6mm - Ø=0.10mm

JD2124.2 probe length L=2mm - Ø=0.15mm

JD2124.4 probe length L=4mm - Ø=0.15mm

JD2124.6 probe length L=6mm - Ø=0.15mm

## GHIANDOLE DI MEIBOMIO/MEIBOMIAN GLANDS INSTRUMENTS



J2122  
Carlini



Roller per espressione delle ghiandole di Meibomio, da utilizzare in associazione alla placca palpebrale di supporto J2120.3

Roller for expression of the meibomian glands, to be used with eyelid plaque J2120.3

J2120.3  
Carlini



Placca palpebrale di supporto per espressione ghiandole di Meibomio. Può essere utilizzata unitamente con il rullo di spremitura J2122

EEyelid plaque support for expression of Meibomian glands. Can be used also together with the roller J2122

J2121  
Alberti



Pinza per espressione ghiandole Meibomiane ostruite a seguito di patologie ad esse correlate. La vite consente di limitare la chiusura a max. 3 mm. La regolazione tra 0 mm (max. spremitura) e 3 mm (min. spremitura) avviene tramite la vite. La forma della punta è studiata per limitare l'invasività dello strumento rendendolo più confortevole per il paziente

Forceps used to express occluded and inflamed Meibomian glands. The screw adjustable mechanism allows opening up to 3 mm. The regulation between 0 mm (max. expression) and 3 mm (min. expression) is obtained with the screw mechanism. The tip has been studied in order to limit the invasiveness of the device obtaining optimal comfort for the patient

# BLEFAROSTATI/SPECULUM



Lieberman  
J2031

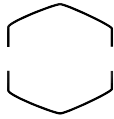

Blefarestato regolabile, leggero,  
valve da 15 mm, a forma di V

Adjustable speculum,  
15 mm long, V-shaped blade

J2032



Blefarestato regolabile,  
leggero, valve piene da 13 mm

Adjustable, solid blade speculum,  
13 mm long blade

Piozzi  
J2039



Blefarestato regolabile **per bambini**,  
valve da 11 mm

Adjustable **child size** wire speculum,  
11 mm long blade

J2039.1

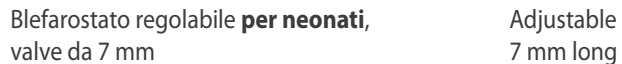

Blefarestato regolabile **per neonati**,  
valve da 7 mm

Adjustable **infant size** wire speculum,  
7 mm long blade

Barraquer  
J2049



Blefarestato **per neonati**,  
valve da 7 mm

**Infant size**, wire speculum,  
7 mm long blade

Barraquer  
J2050

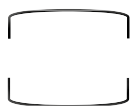

Blefarestato colibrì, valve da 16 mm  
Wire speculum, 16 mm long blade

J2052



Blefarestato **per bambini**, valve da 13 mm  
**Child size** wire speculum, 13 mm long blade

Barraquer  
J2051

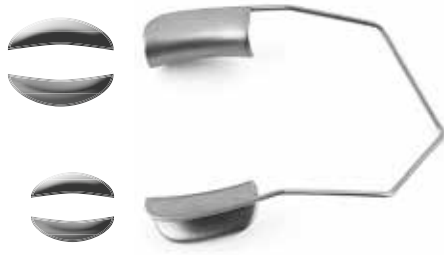

Blefarostato colibrì, valve piene da 14 mm  
Solid blade speculum, 14 mm long blade

J2053



Blefarostato colibrì **per bambini**,  
valve piene da 11 mm

**Child** solid blade speculum, 11 mm long blade

Crozafon®  
J2056.8

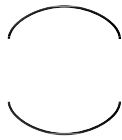

Blefarostato, arcuato, robusto, valve da 15 mm  
Wire speculum curved, strong, 15 mm long blade

J2007

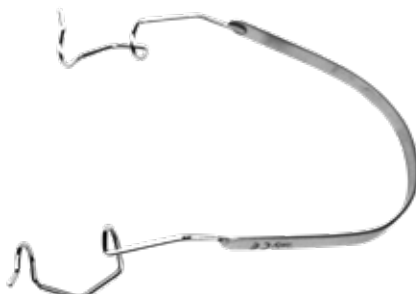
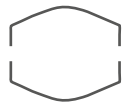

Blefarostato con valve aperte da 15 mm.  
Consigliato per uso diagnostico e chirurgico.  
L'ampio telaio permette facilmente il  
posizionamento e la rimozione sul paziente  
Wire speculum 15 mm blade with large frame.  
Recommended for diagnostic and surgical  
procedures. The wide frame allows easy  
placement and removal

## BLEFAROSTATI MONOUSO/DISPOSABLE SPECULUM



STERILE EO



5 Years  
Shelf Life

JD2007.1/5

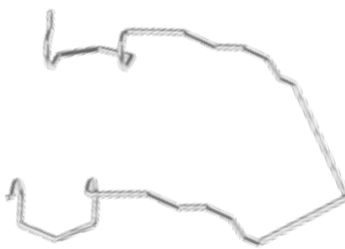

Blefarostato monouso con valve aperte da  
15 mm. Consigliato per uso diagnostico e  
chirurgico. L'ampio telaio permette facilmente  
il posizionamento e la rimozione sul paziente  
Wire speculum disposable 15 mm blade with  
large frame. Recommended for diagnostic and  
surgical procedures. The wide frame allows  
easy placement and removal

JD2056.7/5

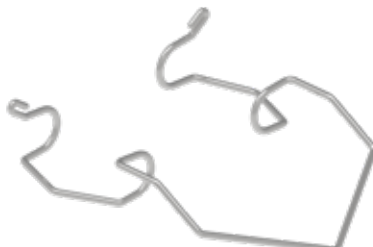

Blefarostato monofilamento  
Wire speculum disposable

JD2010/5

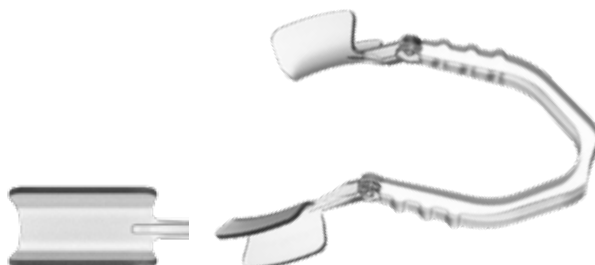

Blefarostato reversibile, valve piene.  
In polimero medicale  
Reverse speculum, solid blade.  
medical polymer. Latex-free

# VIE LACRIMALI/LACRIMAL TOOLS



Ziegler  
J2604



Sonda lacrimale doppia

Double lacrimal probe

J2630.3



Cannula vie lacrimali,  
retta, Ø 0.50 mm, braccio da **15 mm**

25G lacrimal cannula,  
straight, **15 mm long**

J2630.4



Cannula vie lacrimali,  
curva, Ø 0.50 mm, braccio da **17 mm**

25G lacrimal cannula,  
curved, **17 mm long**

De Conciliis  
J2657



Trapano coassiale per endoscopia  
vie lacrimali, Ø 1.2 x 30 mm

Coaxial trephine for lacrimal  
endoscopy, Ø 18G x 30 mm

De Conciliis  
J2658



Trapano per canalicoli lacrimali,  
rastremato 1.2 - 0.8 x 40 mm, **bordi affilati**

Trephine for lacrimal canaliculi,  
tapered 18 - 21G x 40 mm, **sharp edges**

J2631

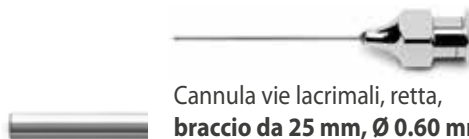

Cannula vie lacrimali, retta,  
**braccio da 25 mm, Ø 0.60 mm**

23G lacrimal cannula, straight,  
**25 mm long**

J2631.2



Cannula vie lacrimali, retta,  
**cono LL mm 0,60 x 12 mm**

23G lacrimal cannula, straight,  
**12 mm long**

J2631.1



Cannula per vie lacrimali, curva  
**cono LL mm 0.60 x 30**

23G lacrimal cannula, curved,  
**30 mm long**

J7030



Cannula per intubazione/infusione  
vie lacrimali doppio calibro, Ø 1-0.60 mm

19-23G tapered lacrimal cannula,  
straight

Bangerter  
J2633.0



Cannula **pediatrica**, poco curva, braccio da  
60 mm, **Ø 0.60 mm**, foro ovale, chiusa in punta

**23G pediatric** cannula, slightly curved,  
60 mm long, oval side port, closed end

J2633.1



Cannula **pediatrica**, poco curva,  
braccio da 60 mm, **Ø 0.80 mm**

**21G pediatric** cannula, slightly curved,  
60 mm long

J2633.2

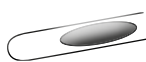

Cannula **per adulti**, poco curva braccio da  
60 mm, **Ø 1.00 mm**

**19G** cannula, **adult**, slightly curved,  
60 mm long

Bangerter  
J2633

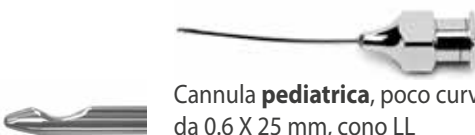

Cannula **pediatrica**, poco curva, smussa,  
da 0.6 X 25 mm, cono LL

**23G pediatric** cannula 25 mm,  
curved, blunt

**Bangerter  
J2633.5**

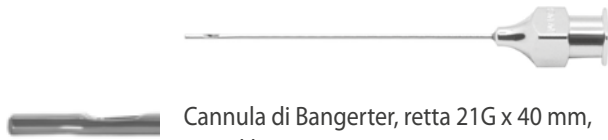

Cannula di Bangerter, retta 21G x 40 mm,  
cono LL

Bangerter cannula,  
straight, 21G x 40 mm

**Bangerter  
J2633.8**

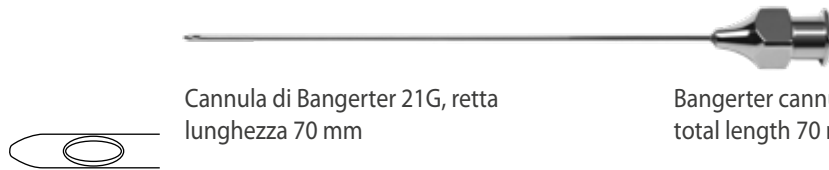

Cannula di Bangerter 21G, retta  
lunghezza 70 mm

Bangerter cannula 21G, straight  
total length 70 mm

**J2633.9**



Cannula di Bangerter 23G, retta  
lunghezza 70 mm

Bangerter cannula 23G, straight  
total length 70 mm

**Bishop-Harmon  
J2655**



Pompetta in silicone J2655.0 con cannula per  
irrigazione cornea J2634.2

Silicone bulb and reusable irrigating  
cannula J2634.2

## BISTURI/KNIVES



**J2310**



Manico Parker per lamette palpebrali smontabili Parker handle for lid blades

**J2311**



Lametta palpebrale, sterile

Lid blades, sterile

**J2315**



Lametta palpebrale, sterile

Lid blades, sterile

## SONDE/DILATATORI . LACRIMAL PROBES AND DILATORS



**Sichel  
J2620.1**



Specillo, **mis. 1, Ø 0.90 mm**

Stylet, **size 1, Ø 0.90 mm**

**J2620.2**



**mis. 2, Ø 1.00 mm**

**size 2, Ø 1.00 mm**

**J2620.3**



**mis. 3, Ø 1.20 mm**

**size 3, Ø 1.20 mm**

**J2620.4**



**mis. 4, Ø 1.35 mm**

**size 4, Ø 1.35 mm**

**J2620.5**



**mis. 5, Ø 1.50 mm**

**size 4, Ø 1.50 mm**

# SONDE/DILATATORI . LACRIMAL PROBES AND DILATORS



## Bowmann

J2610.1	Sonda doppia, cilindrica, <b>mis. 00000/0000</b>	Double ended lacrimal probe, <b>size 00000/0000</b>
J2610.2	<b>mis. 0000/000</b>	<b>size 0000/000</b>
J2610.3	<b>mis. 000/00</b>	<b>size 000/00</b>
J2610.4	<b>mis. 00/0</b>	<b>size. 00/0</b>
J2610.5	<b>mis. 0/1</b>	<b>size 0/1</b>
J2610.6	<b>mis. 1/2</b>	<b>size 1/2</b>
J2610.7	<b>mis. 2/3</b>	<b>size 2/3</b>
J2610.8	<b>mis. 3/4</b>	<b>size 3/4</b>
J2610.9	<b>mis. 4/5</b>	<b>size 4/5</b>
J7010	<b>mis. 5/6</b>	<b>size 5/6</b>

## J2622.1



Dilatatore per vie lacrimali, **sottile**, Ø 0.30 mm Lacrimal dilator, **very fine**, Ø 0.30 mm,

## J2622.2



**fine**, Ø 0.40 mm

**fine taper**, Ø 0.40 mm

## J2622.3



**più tozzo**, Ø 0.40 mm

**heavy taper**, Ø 0.40 mm

## Wilder

### J2625.0



Dilatatore, **mis. 0**, Ø 0.30 mm

Dilator, **size 0**, Ø 0.30 mm

### J2625.1

**mis. 1**, Ø 0.40 mm

**size 1**, Ø 0.40 mm

### J2625.2

**mis. 2**, Ø 0.50 mm

**size 2**, Ø 0.50 mm

### J2625.3

**mis. 3**, Ø 0.60 mm

**size 3**, Ø 0.60 mm

## Castroviejo

### J2624



Dilatatore doppio  
(Ø 0.40 mm - 0.30 mm)

Double-ended lacrimal dilator  
(Ø 0.40 mm - 0.30 mm)

## Giessen

### J2626



Dilatatore angolato, **manico corto**

Lacrimal dilator, angled, **short handle**

### J2627



Dilatatore angolato, **manico lungo**

Lacrimal dilator, angled, **long handle**

## Perone/Incarbone

### J3648



Pinza per stretching lacrimale, azione incrociata, calibrata, punte smusse, scanalatura sulla faccia interna delle branche

Cross-action forceps for stretching lacrimal ducts, blunt, tapered tips

# PINZE DEPILATORIE/CILIA FORCEPS



Henry  
J3600



Pinza depilatoria, lunghezza totale 95 mm      Cilia forceps, total length 95 mm

Barraquer  
J3602



Pinza depilatoria, lunghezza totale 100 mm      Cilia forceps, total length 100 mm

Beer  
J3604



Pinza depilatoria, lunghezza totale 75 mm      Cilia forceps, total length 75 mm

J3610.1



Pinza depilatoria speciale, perfetta, da **1 mm**      Special cilia forceps, **1 mm**

J3610.2



perfetta, da **2 mm**      Special cilia forceps, **2 mm**

J3610.3



perfetta, da **3 mm**      Special cilia forceps **3 mm**

J3610.4



perfetta, da **4 mm**      Special cilia forceps **4 mm**

J3654



Pinza per spine di fico d'India, da **65 mm**      Forceps for prickles, **65 mm**

J3656



Pinza per spine di fico d'India, da **80 mm**      Forceps for prickles, **80 mm**

# STRUMENTI PER CORPI ESTRANEI/FOREIGN BODY TOOLS



J2440

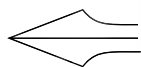

Lancetta per corpi estranei, retta

Foreign body lancet, straight

J2441



Lancetta per corpi estranei, curva

Foreign body lancet, curved

Levinson  
J2442



Cucchiaio per corpi estranei

Foreign body spoon

Bernoulli  
J2444



Cucchiaio per corpi estranei

Foreign body spoon

Levinson  
J2460



Cucchiaio per corpi estranei

Foreign body spoon

Plange  
J2446



Spatola per corpi estranei

Foreign body spatula

J2454



Sgorbia per corpi estranei, smussa

Foreign body gouge, blunt

J2455



Sgorbia per corpi estranei, acuta

Foreign body gouge, sharp

Francis  
J2458



Raschiatore per corpi estranei,  
apice a zappetta

Foreign body spud,  
microhoe shaped tip

# STRUMENTI PER CORPI ESTRANEI/FOREIGN BODY TOOLS

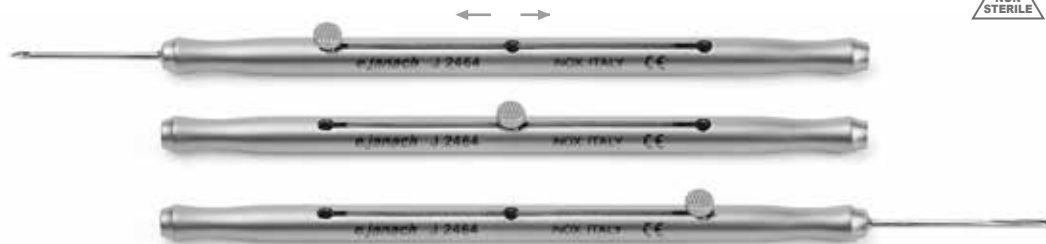
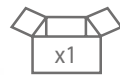

J2464

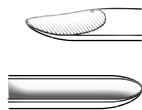

Ago e sgorbia per corpi estranei, in custodia, **fine**

Double-ended foreign body needle and gouge with handle, **fine**

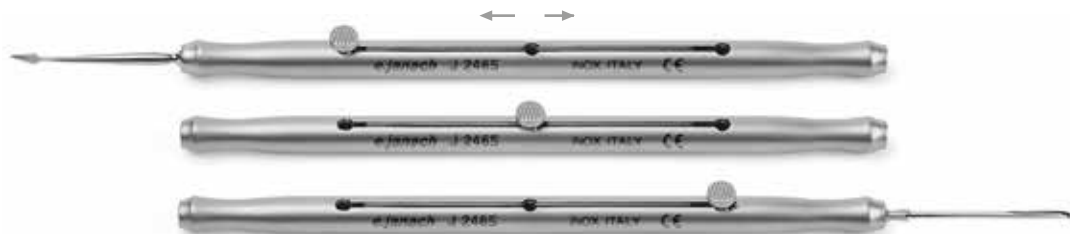

J2465

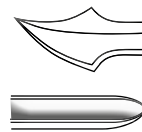

Lancetta e sgorbia per corpi estranei, in custodia

Double-ended foreign body lancet and gouge with handle



Vinciguerra  
J2112A



Spatola per depitelizzazione PRK, consigliata anche per procedure di DSEK/DSAEK, Slam e Pterigio

Epithelium removal spatula, for PRK, also suggested for DSEK/DSAEK, Slam and Pterygium procedures

# MAZZA DA GOLF MONOUSO/DISPOSABLE HOCKEY SPATULA



STERILE EO



JD2112/10

Spatola per depitelizzazione PRK, consigliata anche per procedure di DSEK/DSAEK, Slam e Pterigio

Epithelium removal spatula, for PRK, also suggested for DSEK/DSAEK, Slam and Pterygium procedures

## PINZE DA CALAZIO/CHALAZION FORCEPS

Desmarres  
J3500.1

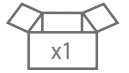

Pinza da calazio, **misura 1 / 20 mm**

Chalazion forceps, **size 1 / 20 mm**

J3500.2



Pinza da calazio, **misura 2 / 26 mm**

Chalazion forceps, **size 2 / 26 mm**

J3500.3



Pinza da calazio, **misura 3 / 31 mm**

Chalazion forceps, **size 3 / 31 mm**

J3500.4

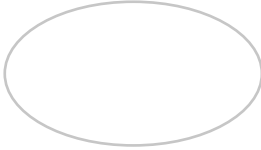

Pinza da calazio, **misura 4 / 34 mm**

Chalazion forceps, **size 4 / 34 mm**

## PINZA DA CALAZIO MONOUSO/DISPOSABLE CHALAZION FORCEPS

JDS3500.2/5



STERILE EO



Pinza da calazio, 23 x 16 mm, acciaio

Chalazion forceps, 23 x 16 mm, steel

JDS3500.3/5



Pinza da calazio, 31 x 17 mm, acciaio

Chalazion forcep, 31 x 17 mm, steel

Ayer  
J3505



Pinza da calazio, **piccola**, misura 11 mm,  
lunghezza totale 9.0 cm

Chalazion forceps, **small**, size 11 mm,  
total length 9.0 cm

Lambert  
J3520



Pinza da calazio, misura 11 mm,  
lunghezza totale 9.0 cm

Chalazion forceps, size 11 mm,  
total length 9.0 cm

Hunt  
J3515



Pinza da calazio, misura 15 mm,  
lunghezza totale 9.5 cm

Chalazion forceps, size 15 mm,  
total length 9.5 cm

## CUCCHIAI DA CALAZIO/CHALAZION CURETTES



Meyhöfer  
J2530.1



Cucchiaio da calazio, **misura 1, Ø 1 mm**

Chalazion curette, **size 1, Ø 1 mm**

J2530.2



**mis. 2, Ø 1.5 mm**

**size 2, Ø 1.5 mm**

J2530.3



**mis. 3, Ø 2 mm**

**size 3, Ø 2 mm**

J2530.4



**mis. 4, Ø 2.5 mm**

**size 4, Ø 2.5 mm**

J2530.5



**mis. 5, Ø 3 mm**

**size 5, Ø 3 mm**

J2530.6



**mis. 6, Ø 4 mm**

**size 6, Ø 4 mm**

J2530.7



**mis. 7, Ø 5 mm**

**size 7, Ø 5 mm**

## DOPPIO CUCCHIAIO DA CALAZIO MONOUSO

### DISPOSABLE DOUBLE CHALAZION CURETTE



STERILE EO



JDS2530/10



Cucchiaio da calazio doppio,  
tondo Ø 2.3, ovale da 3.5 x 2.0 mm

Double chalazion curette,  
round Ø 2.3, oval 3.5 x 2.0 mm

## PINZE PER PUNTI/STITCH FORCEPS

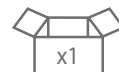

Dumont  
J3683



Pinza media, misura 3,  
retta, acuta, da 120 mm

Medium forceps, size 3, straight,  
pointed tips, overall length 120 mm

Dumont  
J3684



Pinza, misura 4,  
retta, acuta, da 110 mm

Forceps, size 4, straight,  
pointed tips, overall length 110 mm

Dumont  
J3689



Pinza **piccola**,  
retta, acuta, da 90 mm

**Small** forceps, straight,  
pointed tips, overall length 90 mm

Dumont  
J3690



Pinza **angolata 45°**,  
acuta, da 110 mm

Medium forceps, **angled 45°**,  
pointed tips, overall length 110 mm

Dumont  
J3695



Pinza **poco curva**,  
acuta, da 110 mm

Medium forceps, **slightly curved**,  
pointed tips, overall length 110 mm

## JCP0008 SET PER SUTURA/SUTURING SET

5 PER BOX STERILE

**set composto da:  
includes:**

- . Pinza serrafile / Tying forceps
- . Bisturi 22.5° / 22.5° knife
- . Port'aghi / Needle holder



STERILE EO

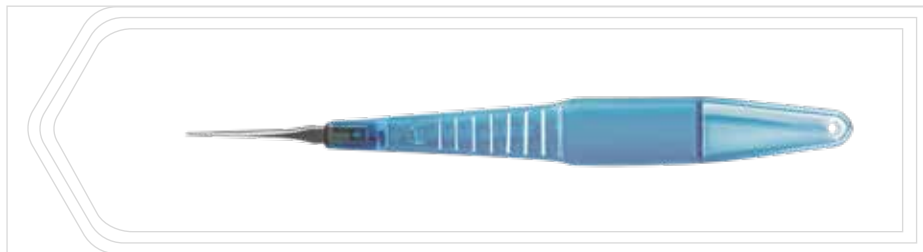
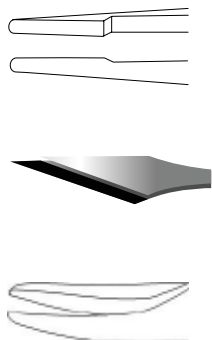

## JCP0015.1 SET ASPORTAZIONE SUTURA/STITCHES REMOVAL SET

5 PER BOX STERILE

**set composto da:  
includes:**

- . Pinza serrafile, acciaio / Tying forceps
- . Microforbice per iride, lame da 6 mm, punte smusse, curva / Iris scissors, 6 mm long blades, blunt tips, curved



STERILE EO

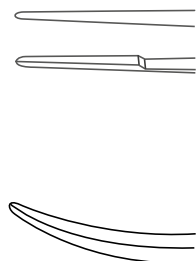

# PINZE ANATOMICHE/DRESSING FORCEPS



J3020



Pinza anatomica, **delicata, retta**, presa zigrinata da 0.60 mm

Dressing forceps, **delicate, straight**, 0.60 mm, serrated jaws

J3022



Pinza anatomica, **delicata, curva**, presa zigrinata da 0.60 mm

Dressing forceps, **delicate, curved**, 0.60 mm, serrated jaws

Castroviejo  
J3020.3

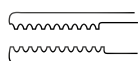

Pinza anatomica, **retta**, presa zigrinata robusta, da 0.70 mm

Dressing forceps, **straight**, 0.70 mm, strong, serrated jaws

J3096.1



Pinza anatomica, **robusta, retta**, presa zigrinata da 0.90 mm

Dressing forceps, **strong, straight**, 0.90 mm, serrated jaws

J3096.2

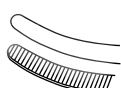

Pinza anatomica, **robusta, curva**, presa zigrinata da 0.90 mm

Dressing forceps, **strong, curved**, 0.90 mm, serrated jaws

# PINZE SERRAFILI E PER PUNTI/TYING AND STITCH FORCEPS

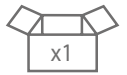

Campos  
J3270

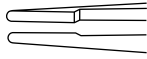

Pinza serrafile e per punti, **retta**,  
con piani da 7 mm

Tying and stitch forceps, **straight**,  
with 7 mm tying platform



Campos  
J3271



Pinza serrafile e per punti, **curva**,  
con piani da 7 mm

Tying and stitch forceps, **curved**,  
with 7 mm tying platform



**Consigliate per suture da 6-0 a 8-0**

**Recommended for 6-0 to 8-0 sutures**

Troutman  
J3277

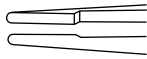

Pinza serrafile e per punti di nylon e  
monofilamento, **retta**,  
con piani delicati da 6 mm

Tying and stitch forceps for nylon and  
monofilament sutures, **straight**,  
with delicate 6 mm tying platform



Troutman  
J3278



Pinza serrafile e per punti di nylon e  
monofilamento, **curva**,  
con piani delicati da 6 mm

Tying and stitch forceps for nylon and  
monofilament sutures, **curved**,  
with delicate 6 mm tying platform



**Consigliate per suture da 8-0 a 10-0**

**Recommended for 8-0 to 10-0 sutures**

# PINZE MONOUSO/DISPOSABLE FORCEPS



STERILE EO



JDS3290.1/10



Pinza serrafile

Tying forceps



JDS3292/10



Pinza serrafile, curva,  
con piani delicati da 4 mm

Tying forceps, curved, with 4 mm  
tying platform, delicate

**Consigliata per suture da 8-0 a 10-0**

**Recommended for 8-0 to 10-0 sutures**



# FORBICI PER PUNTI E CHIRURGIA/STITCH AND SURGERY SCISSORS

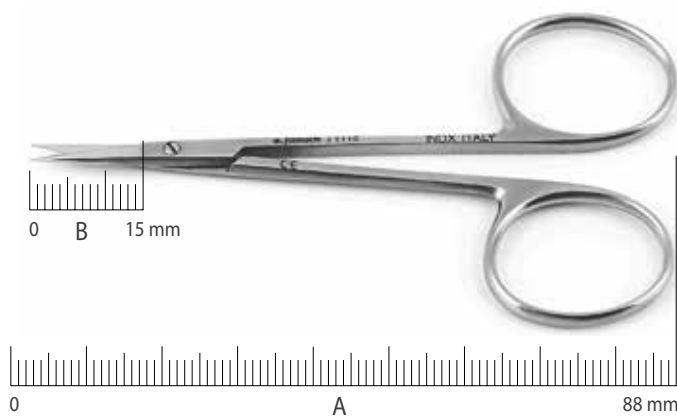
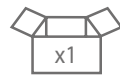

COD	A	B	Descrizione	Description
J1110	88	15	fine, retta, acuta	thin, straight, pointed tips
J1112	88	15	fine, retta, smussa	thin, straight, blunt tips
J1114	88	15	fine, curva, acuta	thin, curved, pointed tips
J1116	88	15	fine, curva, smussa	thin, curved, blunt tips

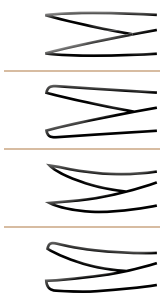

COD	A	B	Descrizione	Description
<b>Spencer J1285</b>	90	21	per punti, retta, destra smussa, sinistra con apice ad uncino	stitch scissors, straight, right blunt tip and left hook-shaped tip

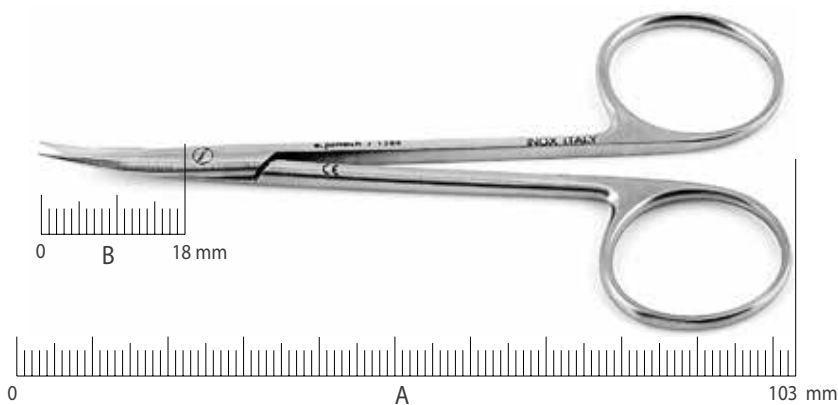

COD	A	B	Descrizione	Description
J1286	103	18	per punti, curva, acuta	stitch scissors, curved, pointed tips



## FORBICE MONOUSO/DISPOSABLE SCISSORS



STERILE EO

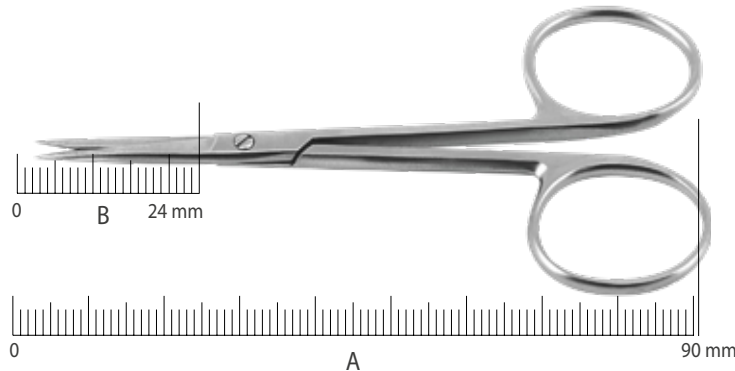

COD	A	B	Descrizione	Description
JDS1010/10	90	24	lunga 90 mm, retta, punte acute, lame da 24 mm	90 mm long scissors, straight, 24 mm long blades, pointed tips

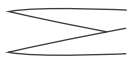

## FORBICI PER PUNTI E CHIRURGIA/STITCH AND SURGERY SCISSORS

Vannas  
J1550



Forbice per iride,  
retta, acuta, lame delicate da 4 mm

Iris scissors,  
straight, 4 mm, delicate blades, pointed tips



Vannas  
J4200

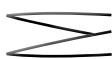

Forbice per iride,  
retta, smussa, lame da 6 mm

Iris scissors,  
straight, 6 mm blades, blunt tips

## FORBICE MONOUSO/DISPOSABLE SCISSORS

JDS1502/5



Forbice corneale curva e smussa

Corneal scissors, curved, blunt tips



STERILE EO



JDS4201/10



Microforbice per iride, punte smusse,  
curva, lame da 6 mm

Iris scissors, curved,  
6 mm long blades, blunt tips



STERILE EO



## PORT'AGHI/NEEDLE HOLDER



Castroviejo  
J4080



Port'aghi,  
retto, **senza arresto**, da 118 mm

Needle holder,  
straight, **without lock**, overall length: 118 mm

J4081



curvo, senza arresto

curved, without lock

J4084

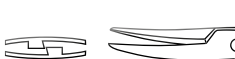

retto, con arresto

curved, with lock

J4085



curvo, con arresto

curved, with lock, overall length

**Consigliate per suture da 6-0 a 8-0**

**Recommended for 6-0 to 8-0 sutures**



Castroviejo  
J4060



Port'aghi robusto,  
retto, **senza arresto**, da 145 mm

Needle holder,  
straight, **without lock**, overall length: 118 mm

J4061



curvo, senza arresto

curved, without lock

J4064



retto, con arresto

curved, with lock

J4065



curvo, con arresto

curved, with lock, overall length

**Consigliate per suture da 4-0 a 7-0**

**Recommended for 4-0 to 7-0 sutures**

## PORT'AGHI MONOUSO/DISPOSABLE NEEDLE HOLDER



STERILE EO

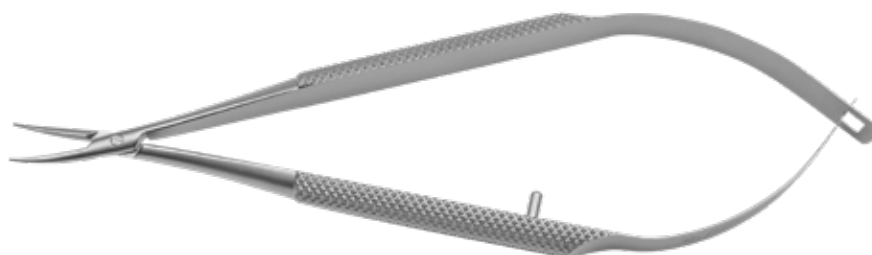

JDS4061/10



Port'aghi in acciaio, robusto, curvo,  
senza arresto, da 145 mm

Stainless steel needle holder, curved,  
without lock, overall length: 145 mm

## PLACCA/LID PLATE



Jaeger  
J2120

Placca, satinata

Lid plate, glazed

# ELEVATORI PALPEBRALI/LID RETRACTORS



Desmarres  
J2100



Elevatore palpebrale, per neonati, 4 mm

Lid retractor, for infants, 4 mm blade

J2100.0



Elevatore palpebrale, per bambini, 7 mm

Lid retractor, pediatric, 7 mm blade

J2100.1



Elevatore palpebrale, 12 mm

Lid retractor, 12 mm blade

J2100.2



Elevatore palpebrale, 14 mm

Lid retractor, 14 mm blade

J2100.3



Elevatore palpebrale, 16 mm

Lid retractor, 16 mm blade

J2100.4



Elevatore palpebrale, 18 mm

Lid retractor, 18 mm blade

# ELEVATORE PALPEBRALE MONOUSO/DISPOSABLE LID RETRACTOR



STERILE EO



JDS2100.2/10



Elevatore palpebrale Desmarres, 14 mm

Lid retractor Desmarres, 14 mm

Worst-Dragoni  
J2615.1



Pigtail probe per ricostruzione vie lacrimali,  
**per adulti**

Pigtail probe with suture holes,  
**for adults**

J2615.2



**per bambini**

**pediatric**

# SCATOLE/STERILIZATION TRAY

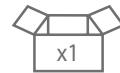

J4702

Scatola in PSU, con tappeto in silicone,  
dimensioni esterne: 18.1 x 4.9 x 1.8 cm

**Consigliata per 2 pinze vitreali**

PSU sterilization tray, with silicone mat,  
outer dimensions: 18.1 x 4.9 x 1.8 cm

**Recommended for 2 retinal instruments**



J4703

Scatola in PSU, con tappeto in silicone,  
per 3-5 strumenti,  
dimensioni esterne: 16 x 7 x 2 cm

**Tappeto silicone per J4703**

PSU sterilization tray, with silicone mat,  
fits 3-5 instruments,  
outer dimensions: 16 x 7 x 2 cm

**Silicone mat for J4703**

J4703.1



J4710

Scatola in PSU, con tappeto in silicone,  
per 5-7 strumenti,  
dimensioni esterne: 19.9 x 11 x 2.5 cm

PSU sterilization tray, with silicone mat,  
fits 5-7 instruments,  
outer dimensions: 19.9 x 11 x 2.5 cm



J4705

Scatola in PSU, polisulfone,  
dimensioni esterne: 18.1x4.9x1.8 cm con fermo  
**Consigliata per due pinze vitreali**

PSU sterilisation tray,  
outer dimensions: 18.1x4.9x1.8 cm  
**Recommended for 2 retinal instruments**



J4564

Cesto traforato 270 X 170 X 35 mm, tappeto silicone, ferma strumenti a coda di rondine, coperchio con maniglia

Perforated basket with handles 270 X 170 X 35 mm, with silicone mat and silicone stopper. Fits boxes J4577 and J4578

J4564.1

Cesto traforato 200 x 170 x 35 mm, tappeto silicone, ferma strumenti a coda di rondine, coperchio con maniglia

Perforated basket with handles 200 x 170 x 35 mm, with silicone mat and silicone stopper



J4708

Scatola in PSU con fermo, dimensioni: 20.3x11.4x1.5 cm (misure interne)  
**Consigliata per 6 strumenti**

PSU tray with stop, 20.3x11.4x1.5 cm (inner dimensions)  
**Recommended for 6 instruments**

## CAUTERIO MONOUSO DISPOSABLE CAUTERY

10 PER BOX STERILE



STERILE EO



4 Years Shelf Life



Bovie BBAA00

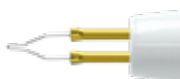

Cauterio monouso - **punta fine**

Disposable cautery - **fine tip**

Bovie BBAA01

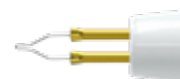

Cauterio monouso ad **alta temperatura**

**High temperature** disposable cautery

Bovie BBAA04

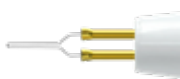

Cauterio monouso - **punta allungata**

Disposable cautery - **elongated tip**

Bovie BBAA90



Cauterio monouso - **punta microfine**

Disposable cautery - **ultrafine tip**

# ASCIUGHINI/SPONGES











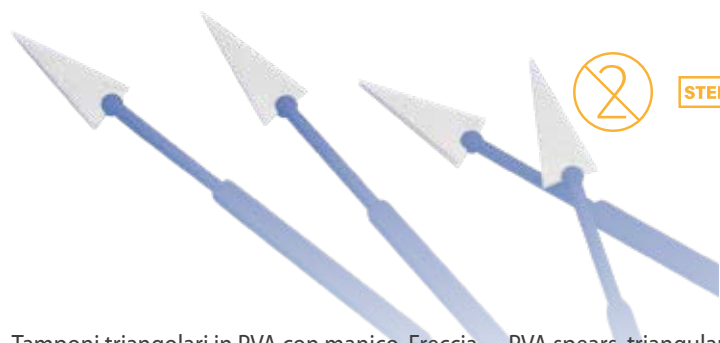

**Tamponi rettangolari, Conf. da 200 pz. sterili, in 20 buste da 10 pz.**

**Cellulose sponges, Box of 200 sterile items, 20 packs of 10 pieces each**

J4489



**Tamponi triangolari in PVA con manico. Freccia assorbente: 100% Poly Vinyl Alcohol (PVA) in spugna. Manico: polipropilene, dimensioni: 3.85 x 53.5 mm. Conf. da 200 pz. sterili, in 20 buste da 10 pz.**

**PVA spears, triangular, with handle. 100% Polyvinyl Alcohol (PVA) sponge absorbent arrow. Polypropylene handle, dimensions: 3.85 x 53.5 mm. Box of 200 items, 20 pack of 10 sterile units**

J4491







**Bastoncini Viscotex, tessuto non tessuto, 5x66 mm. Conf. da 400 pz sterili, in 20 buste da 20 pz.**

**Viscotex sponges non woven cloth, 5x66 mm. Box of 400 sterile items, 20 packs of 20 sponges each**

J4496.1





J4496.2



**Conf. da 500 pz. non sterili**

**Box of 500 non-sterile items**



**Sponge rotondo in PVA, diametro da 8 mm. Conf. da 20 pz. sterili**

**PVA sponge disk shaped, 8 mm diameter. Box of 20 sterile units**

J4494.1

J4428

Protettore oculare trasparente post intervento, universale, sterile.

**Confezione da 100 pz sterili**

Eye shield, clear, universal, sterile.

**Box of 100 sterile units**



J4428.0

**Non sterile. Venduto singolarmente**

**Non sterile. Individually packed**

Viscot® V1425SR-10  
10 PER BOX STERILE



Penna dermografica Viscot® con punta doppia: ultra fine e media

Double tip Viscot® dermographic pen: ultra fine and medium

J4608.10



## STAINLESS STEEL BOWL

Ciotola in acciaio inossidabile Ø 40 h. 25, capacità 15 cc.

Stainless steel bowl Ø 40 h. 25, capacity 15 cc.

J4608.20

Ciotola in acciaio inossidabile Ø 60 h. 35, capacità 75 cc.

Stainless steel bowl Ø 60 h. 35, capacity 75 cc.

J4608.30

Ciotola in acciaio inossidabile Ø 80 h. 45, capacità 225 cc.

Stainless steel bowl Ø 80 h. 45, capacity 225 cc.

J4608.40

Ciotola in acciaio inossidabile Ø 100 h. 55, capacità 325 cc.

Stainless steel bowl Ø 100 h. 55, capacity 325 cc.

J4608.50

Ciotola in acciaio inossidabile Ø 120 h. 65, capacità 500 cc.

Stainless steel bowl Ø 120 h. 65, capacity 500 cc.

J4608.60

Ciotola in acciaio inossidabile Ø 150 h. 80, capacità 900 cc.

Stainless steel bowl Ø 150 h. 80, capacity 900 cc.

J4608.70

Ciotola in acciaio inossidabile Ø 180 h. 95, capacità 1600 cc.

Stainless steel bowl Ø 180 h. 95, capacity 1600 cc.

J4608.80

Ciotola in acciaio inossidabile Ø 200 h. 100, capacità 2000 cc.

Stainless steel bowl Ø 200 h. 100, capacity 2000 cc.

J4608.90

Ciotola in acciaio inossidabile Ø 220 h. 115, capacità 3300 cc.

Stainless steel bowl Ø 220 h. 115, capacity 3300 cc.

J4608.99

Ciotola in acciaio inossidabile Ø 240 h. 125, capacità 4000 cc.

Stainless steel bowl Ø 240 h. 125, capacity 4000 cc.

**J5001 \***  
CONF. DA 12 FLACONI DA 120 ML  
BOX OF 12 BOTTLES 120 ML

\* Il prodotto può essere venduto ed utilizzato solo da medici professionisti in strutture ambulatoriali, pubbliche o private e nelle sale operatorie. Esclusa la vendita al dettaglio

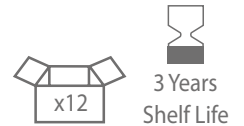

TSL 44, soluzione detergente, disinfettante, senza risciacquo, ideale per dispositivi ed accessori oftalmici a contatto

TSL 44, detergent and disinfectant solution for ophthalmic contact items

\* Only for domestic market

**J5003 \***  
Detergente Polienzimatico da 1L

\* Il prodotto può essere venduto ed utilizzato solo da medici professionisti in strutture ambulatoriali, pubbliche o private e nelle sale operatorie. Esclusa la vendita al dettaglio

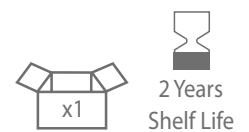

Sistema detergente ad azione plurienzimatica. Specifico per la preliminare rimozione di sangue e contaminanti organici dai dispositivi da sottoporre a successiva disinfezione o sterilizzazione. Indicato per lavaggi manuali ad immersione, per lavastrumenti e ultrasuoni

Multi-enzymatic detergent system. Specific for the preliminary removal of blood and organic contaminants from devices to be later disinfected or sterilized. Suitable for manual immersion washing, for washing and ultrasounds machines

\* Only for domestic market

## FLURO TOUCH

FLUORESCEIN SODIUM OPHTHALMIC STRIPS

STRISCE OFTALMICHE DI FLUORESCEINA SODICA

### MIPL/A4

Strisce oftalmiche di fluoresceina sodica, 1 mg. Singole buste, confezione da 100 pz.

Fluoroscain sodium ophthalmic strips, 1 mg. 100 per box, individually packed sterile



grasp tabs between thumbs & index fingers



gently pull tabs apart



remove strip taking care to touch only the white portion of the strip



# OTHER BROCHURES...

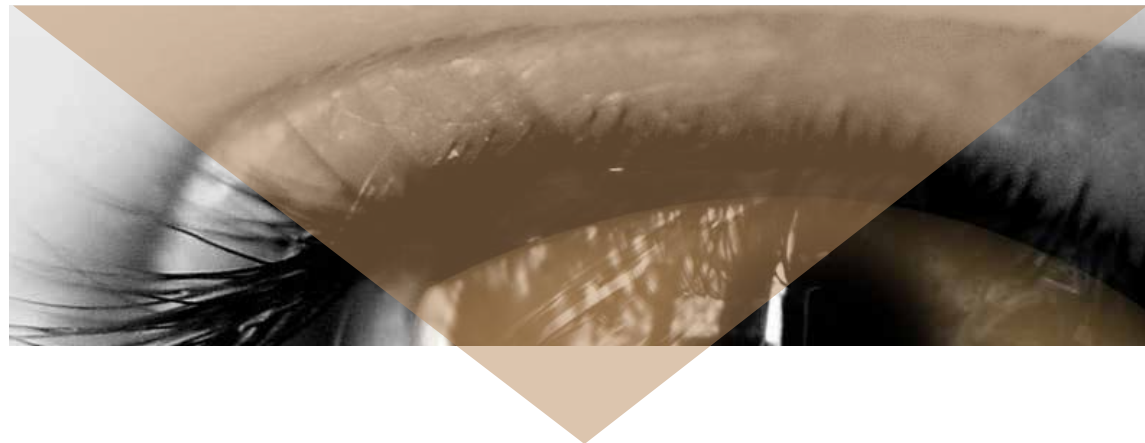
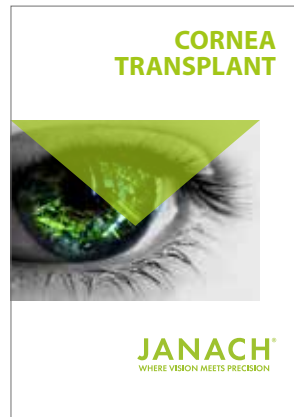

Organismo accreditato da ACCREDIA  
Body accredited by ACCREDIA

**JANACH®**  
WHERE VISION MEETS PRECISION

Via Negretti, 3 - 22100 Como - Italy  
Tel. +39 031574088 - [international@janach.it](mailto:international@janach.it) - [janach.it](http://janach.it)

© Copyright: E.Janach  
BRO.119.03.26/IT/EN - EDI.5